

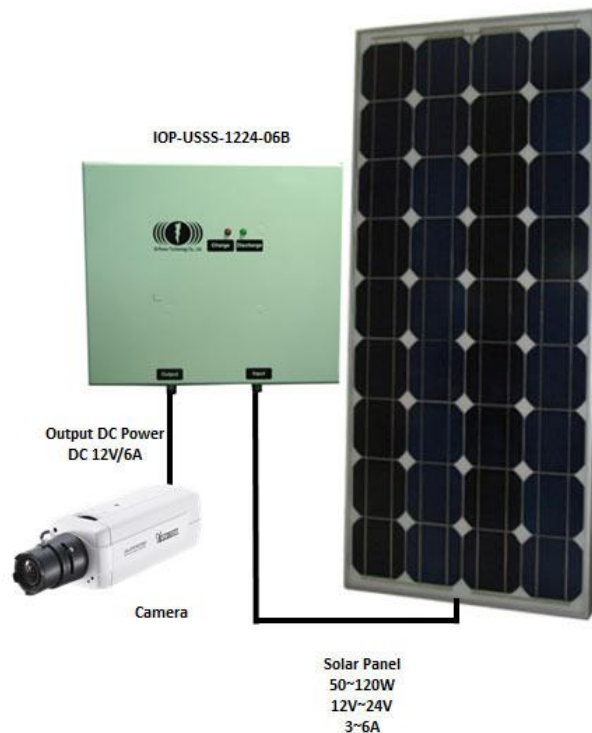

IO-Power USSS-12V1224-OA Series

Cloudy-Solar Collection Model

Next Generation Online Type Solar Energy Collection
Power Generation System



IOP-USSS-12V1224-OA Series

User Manual

IOP-USSS-1212-06B

IOP-USSS-1216-07B





IOP-USSS-1218-08B

IOP-USSS-1224-09B



V. 13. 003_0125



Directory

Trademark and Copyright Notice.....	4
About this manual	4
Product Warranty	5
Housing Warranty	5
Fully electronic micro processing control boards warranty.....	5
Special M12 to Solar Connector Cable for wiring of warranty	5
C-LiFePO4 Lithium Batteries warranty	7
Attention of the Product storage	7
 High and low temperature storage	7
 Low-voltage storage	7
 Regular maintenance of low voltage storage	8
 Activate the system	8
 Special attention for the Product	8
Product Specification.....	11
Product Specification Selection Evaluation.....	14
Firstly to confirm the power consumption of the devices	14
Estimated DC UPS battery capacity calculation	15
C-LiFePO4 Lithium Batteries Capacity V.S. C Value of charging and discharging.....	15
Consideration for environmental characteristics (for C-LiFePO4 Lithium Batteries).....	17
Product Installation Instructions.....	18
Click the Solar Energy joint (please do an extra waterproof protection)	18
DC M12 Male to DC M12 Female for input.....	18
Take aim at M12 Male and plug in M12 Female and spin to tighten the connectors (please do an extra waterproof protection)	18
DC M12 Female to DC M12 Male for output	19



Take aim at M12 Female and plug in M12 Male and spin to tighten the connectors (please do an extra waterproof protection)	19
DC Extend Connector / DC Extend Cable	19
Mounting instruction.....	20
Firstly, put the waterproof rubber gaskets on the screws	20
Then set the screw, through another set of waterproof rubber gaskets, on the stainless steel bracket ..	20
Finally, screw the bracket tight into the screw holes in the bottom side of the housing.....	20
Pole fixation.....	20
Wall fixation.....	20
Product Use Instructions.....	21
External power input description	21
 First time to activate	21
DC power output description	21
 Recovery after low-voltage-discharge-termination instruction	21
C-LiFePO4 Lithium Batteries charging	22
LED Display	23
 LED display considerations	23
Product application	24



Trademark and Copyright Notice

IOP-USSS-12V1224-OA series is Cloudy-Solar Collection Model online power voltage regulator power systems; IO-Power Technology Limited a registered trademark.





All parts of the product, including software and accessories, their copyrights are owned by IO-Power Technology Limited, without IO-Power Technology license, transcript may not be any imitation, copying or translation.

Product specifications and information referred to in this manual are for reference only, specification changes, without prior notice, please consult with agent or dealer before purchase latest product specification data.

About this manual

This manual discusses IO-Power Technology Cloudy-Solar Collection Model online power voltage regulator power systems, through the operation of the content of this article to address the problems of outdoor power-seizing.

This manual uses the following criteria to communicate instructions and information:

	C-LiFePO4 Lithium Batteries
 NOTE	Readers' "attention". These attentions to include the special conditions referred to in this manual or use the recommendation and note references.
 CAUTION	Readers' "beware". In this case, readers can result in equipment damage or risks.
 WARNING	Hazard. Means that there is a potential risk that can result in physical damage. Before using any equipment, please pay attention to the risks associated with the circuit, as well as familiar with standard practices required to prevent accidents from happening.

Bold: It means an important function and set of steps that require your attention.



Product Warranty

Housing Warranty

IOP-USSS-12V1224-OA series is Cloudy-Solar Collection Model online power voltage regulator and power systems, made of protection-grade iron material metal casing, complemented by professional antirust paint, suitable for indoor and outdoor harsh environments.

In accordance with the user manual to operate and use this product in non-human misuse case, buyer will have 1 year warranty guarantee.

Fully electronic micro processing control boards warranty

IOP-USSS-12V1224-OA series uses chip microprocessor design, micro-controller design for online charging and discharging Control Board, Control Board at $-20^{\circ}\text{C}\sim 70^{\circ}\text{C}$ under normal operation.

Charge / Discharge current of current control board were 7 A, $-20^{\circ}\text{C}\sim 70^{\circ}\text{C}$ temperature protection, when product temperatures is above 70°C , all micro-controller will automatically stop charging and discharging operations, it must be cool or under the limited high temperature, the system will be activated again.

In accordance with the user manual to operate and use this product in non-human misuse case, buyer will have 1 year warranty guarantee.

Special M12 to Solar Connector Cable for wiring of warranty

Solar DC input voltage ranged DC 12V~28V, DC current 7A Max enter the maximum, access panels to match capacity to 60W~130W/7.5A, M12 to special Solar Connector Cable for connection to correspond with special connectors for solar panels.

In accordance with the user manual to operate and use this product in non-human misuse case, buyer will have 1 year warranty guarantee for Solar Connector Cable wiring. (M12 to Solar Connector Cable is only rated IP65 waterproof protection. Please is place it in the power distribution box and do waterproof protection)

Please use "Tyco" Solar connector.

(TYCO) 1394462 - 4 Male (positive input) & (TYCO) 6 - 13994461 - 2 Female (negative input).

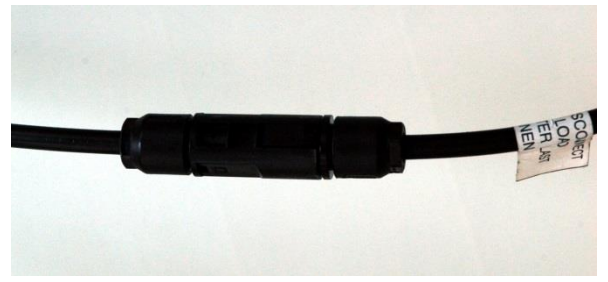
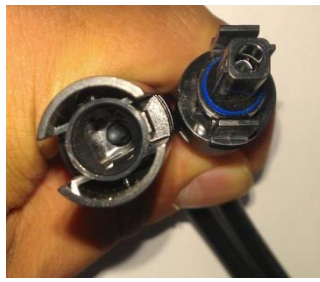
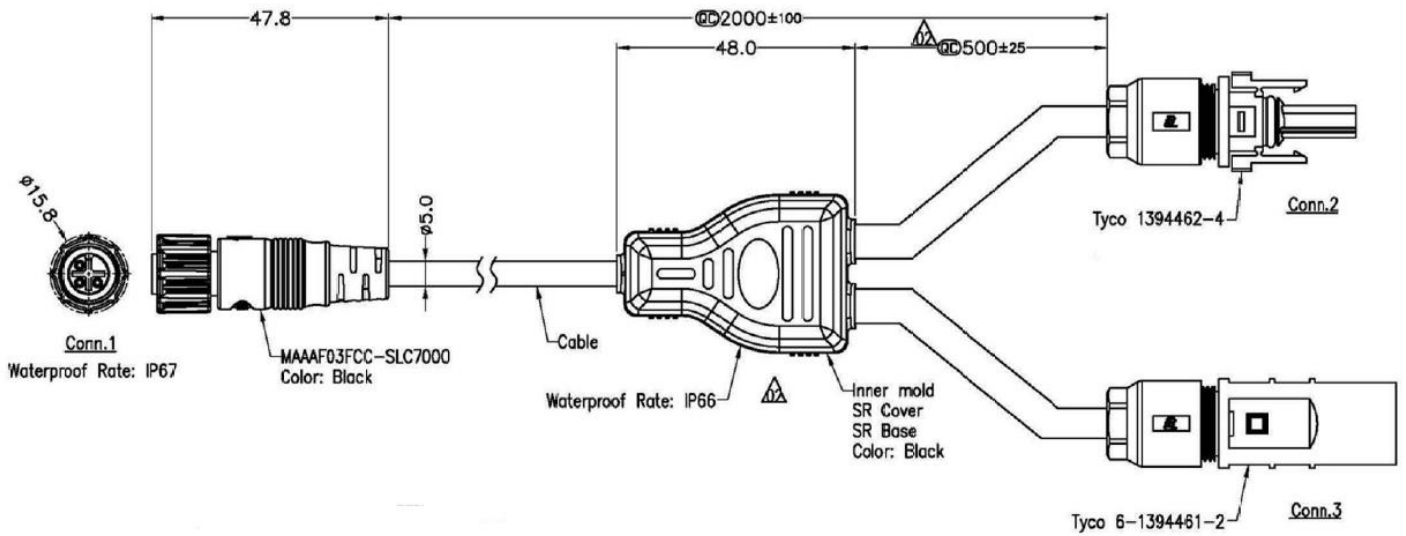

Note: You can contact with your Solar Panel supplier to replace use the Tyco Solar Connector.



C-LiFePO4 Lithium Batteries warranty

IOP-USSS-12V1224-OA series adopts the latest technologies of high and low temperature resistance of C-LiFePO4 Lithium Batteries, supported by:

Automatic detection of abnormal voltage or false battery status and execution of battery charging protection *

Battery low voltage protection with zero power consumption *

Balancing charge / discharge protection *

... Patent design and unique microprocessor system for charging and discharging control management, C-LiFePO4 Lithium Batteries characteristics is fully played.

In accordance with the user manual to operate and use this product in non-human misuse case, buyer will have 1 year warranty guarantee for 1 year warranty or 500 times of charge and discharge cycle.

(Extension of the warranty period and the number of cycle life 500 times, product warranty guarantee may be extended: 1year/500 times will cost another 10%)

Attention of the Product storage



High and low temperature storage

IOP-USSS-12V1224-OA series adopts the latest technologies of high and low temperature resistance of C-LiFePO4 Lithium Batteries and ability to import static zero-power. But after the charge and discharge test before shipping, the system is on low-consumption detecting status. Storage temperature must be between 20°C ~35°C to remain the normal operation of stockpile security and subsequent use of products.



Low-voltage storage

IOP-USSS-12V1224-OA series uses static zero power function. But after the charge and discharge test before shipping, system stays in low voltage, low power reconnaissance operation status. When C-LiFePO4 Lithium Batteries discharge to 11V±3%, the built-in charging and discharging micro-processing controller will automatically execute low-voltage-discharge-termination protection, so user should regularly detect for low voltage status, to keep stockpile safe and subsequent use of product.



The lowest discharging voltage of this product is 9V+/-3%, and the highest voltage discharge protection for 14.4V+/-3%.



Regular maintenance of low voltage storage

IOP-USSS-12V1224-OA series adopts the storage under low-voltage and low-power consumption status, we strongly recommend that after obtaining the products, charge the battery for 8 hours for the first time, and then charge the battery once every 3 months.

(Fully-charged C-LiFePO4 Lithium Batteries stored @ 25°C for 1 year, its power capacity will remain 90%. After charging, its power capacity will lift to 95~97 %.)



Activate the system

IOP-USSS-12V1224-OA series adopts low voltage detection operation for low power consumption storage, when the battery voltage is below 11V+/-3%, microprocessor will execute the termination. After the outer power is put in, it will activate the system in 10 seconds. And then the PCBA will start to charge the C-LiFePO4 Lithium Batteries, and supply for the supported equipment at the same time.

After the first time to activate the system, before Cloudy-Solar Collection Model System executes the low-voltage-discharge-termination, DC UPS power system can detect the discharging status. Once the supported equipment is plugged in, the system will automatically supply power for the equipment.



Special attention for the Product

IOP-USSS-12V1224-OA series adopts the latest technologies of high and low temperature resistance for C-LiFePO4 Lithium Batteries. The characteristics of C-LiFePO4 Lithium Batteries are very different from the lead-acid batteries and other types of batteries. C-LiFePO4 Lithium Batteries made by different manufacturers design different characteristics in product, including the operating voltage and operation current. This product uses C-LiFePO4 Lithium Batteries. Users shall pay more attention on list below:

1. Please use the product in accordance with the product specification data. Please do not remove or change this equipment without authorization of any of the main parts, so as to avoid the safe use of the extension of the problem.



2. Do not proceed heating over 80°C or put it close to fire or keep it less than -40°C to directly cooling down. It might cause damages for electronic components and the batteries.
3. When the product housing is over 70°C, do not carry out charging and discharging operation to avoid danger.
4. Do not place this product in high humidity and put it into water or close to the highly volatile chemical solvents to avoid danger.
5. Installation and assembly connectors in accordance with product instructions, not adjacent to the wrong wire connection to avoid the danger.
6. Do not use hammer or other items to strike this product, trample on the battery, cause strong impact, or throw, drop this product to avoid danger.
7. Before using this product, any action to charge and discharge the battery of this product, please be sure to read the manual in detail and with care.
8. When the C-LiFePO₄ Lithium Batteries is discharging and being discharged, please keep it away from other conductive objects.
9. When recycling the batteries, please be sure that the battery (+) (-), short circuit is isolated to avoid danger.
10. The C-LiFePO₄ Lithium Batteries has a life cycle, when the battery life-cycle ends, please contact your seller to replace same battery.
11. Be aware of the abnormal heat, flame, shape, smell, color, and other abnormal conditions, please immediately discontinue your use of the product and contact the seller as soon as possible or contact IO-Power Technology company.
12. When erecting IOP-USSS-12V1224-OA series, if there is more space in the distribution box or patch box space license case, we recommend this product fixed inside the box, it will help to reduce this product at the risk of excessive high temperature operating temperature.
13. When erecting IOP-USSS-12V1224-OA series, if possible, we recommends that this product fixed to the Lee side, or not to be in the rain, it will help to reduce this product is too high or low humidity and rain water environments such as operational risks.







14. When erecting IOP-USSS-12V1224-OA series, if possible, we recommend this product fixed on the back of sunshine, or not to be shined, it will help to reduce the heat caused by excessive heat and sunshine to protect the product body and wiring from speeding-up aging from the environmental risks.
15. When erecting IOP-USSS-12V1224-OA series, even this products is rated IP66~IP67 of waterproof and dustproof grade, but for a sound safety for indoor and outdoor use, we suggest to proceed professional waterproof protection. Using general PVC tape for waterproof with 2 levels can reach the effect of waterproof and dustproof.



Product Specification

IOP-USSS-12V1224-OA Series Specification (* Patent Pending)

Model	IOP-USSS-1212-06B	IOP-USSS-1216-07B	IOP-USSS-1218-08B	IOP-USSS-1224-09B
Outdoor Model M12 Connector Aluminium Radiating Airtight Housing IP 67				
Power Capacity	148 WH (11.6Ah@12.8V)	206 WH (16.1Ah@12.8V)	235 WH (18.4Ah@12.8V)	297 WH (23.2Ah@12.8V)
Solar Cell Input DC Voltage / Current	DC 12V~28V 24V/7A Max	DC 12V~28V 24V/7A Max	DC 12V~28V 24V/7A Max	DC 12V~28V 24V/7A Max
Suggestion Solar Cells Max Voltage / Open Circuit Voltage Maximum Current	60~80W 16~18V / 21~23V 4~6A	70~90W 16~18V / 21~23V 4~6A	80~100W 16~18V / 21~23V 4~7A	90~120W 16~18V / 21~23V 4~7A
DC to DC for Device	DC 11.5V~14.4V +-3% 6A Max			
DC to DC for Battery	14.4V +-3% 3~4.8A Max			
Transform Efficiency	90%~ Electronic MPPT Effectiveness			
Protection	<p>Online Type Cloudy-Solar Energy Collection uninterruptible operating system, power uninterruptible (monitor will not be black screen)</p> <p>Solar cell 12V~28V automatic input voltage detection</p> <p>Cloudy collection of solar cells can be charged *</p> <p>Solar cell reverse charge protection</p> <p>Built-in Li-Fe battery BMS/PCM voltage balance management</p> <p>Battery charge/discharge protection ' would not be either battery core fault ' affect the operation of ontology and its</p> <p>Automatic detection of abnormal voltage or battery status and fault exception of battery charging protection *</p> <p>Battery positive and negative polarity of the anti-protection</p> <p>Low-voltage zero-power battery protection *</p> <p>Balancing charge/discharge protection *</p> <p>Charge/discharge limit current protection</p> <p>Battery overcharge protection</p>			



	Over discharge protection Over temperature protection Input power overcurrent protection Input power supply over voltage protection Short circuit protected Fuse			
Support Battery Type	C-LiFePO4 Lithium Batteries			
Battery Capacity	11.6Ah @ 12.8V (148 WH)	16.1Ah @ 12.8V (206 WH)	18.4Ah @ 12.8V (235 WH)	23.2Ah @ 12.8V (297 WH)
Battery Charge Mode	CCP/CVP MCU Control			
Battery Charge Voltage	14.4V +- 3%			
Battery Charge Float Voltage	13.6V +- 3%			
Battery Cut-off Discharge Voltage	11.5V +- 3%			
Battery recovery discharge voltage	12.4V +- 3%			
Standard Charge Current	3.6A			
Max. Charge Current	7A			
Standard Discharge Current	3A			
Max. Discharge Current	6A			
Solar Cell 80W @ 6hrs @ 360MJ/m2 Charging Time @95% Capacity	Non discharge 2.5hrs On line discharging 4hrs	Non discharge 3hrs On line discharging 4.5hrs	Non discharge 4hrs On line discharging 5hrs	Non discharge 4.5hrs On line discharging 6hrs
Battery Cycle Life (80% Capacity) 0.2C Charging 0.5C Discharge	@ 25°C 2000 Times @ 45°C 1600 Times @ 50°C 1200 Times @ 60°C 550 Times @ 60°C 720 Times 70% Capacity			
Industrial Housing & Connector	Aluminium Radiating Airtight Housing IP67 M12 Connector and Solar Panel Connector			
Connector Type	1.Enter the solar DC power supply: Input DC 6~28V M12 Female 2.Output: 12V M12 Female to DC Jack Female			



	3.Solar Panel Connector Cable Tyco. 1394462-4 (Male) & Tyco. 6-13994461-2 (Female)			
Operating Temperature (Discharge)	-20°C ~ 60°C 20~40°C Battery Capacity:100% -10°C Battery Capacity : 60% -20°C Battery Capacity : 48%			
Charging Temperature	-30°C ~ 60°C			
Storage Temperature	-20°C ~ 40°C			
Rel. Humidity	10~95%RH			
Storage Time	6 months (Stored charge once every three months) (Before the Use, please First Charge)			
Dimension	209(L)x139(W)x210mm(H)			
Weight	2.5Kg (Box 3.1Kg) (2Pcs/Carton)	3.0Kg (Box 3.6Kg) (2Pcs/Carton)	3.2Kg (Box 3.9Kg) (2Pcs/Carton)	3.8Kg (Box 4.4Kg) (2Pcs/Carton)
LED Indicator	1.Input AC power LED-red full light (Battery capacity more than 95%) 2.Input AC power LED-red flash light (Battery is charging) 3.Battery is charging, Insert the 12V device load, LED-green flash light 4.Battery non charging, Insert the 12V device load, LED-green full light			
Housing	IP67			
Approvals	. CE, FCC			
Installation	1.Street lamp pole mount 2.Upright pole mount 3.Wall mount installation			
Warranty	12 months			
Carton Size	490*340*155mm			

Note 1: battery capacity +-5%

Note 2: Product specifications change, without notice, consultation with agent or dealer before buying the latest specifications



Product Specification Selection Evaluation

Firstly to confirm the power consumption of the devices

Power consumption evaluation Description:

Usually, the current claimed on the device (EX: cameras) adapter is not the “actual power consumption” for normal working. We suggest asking the technical support from the Original-Design company for the actual power consumption for a precise evaluation.

The current claimed on the device (EX: cameras) adapter is usually for the transient current when starting the device. Therefore, it is usually much higher than its normal working power consumption. IOP-USSS-12V1224-OA series can support 12V/7A above of the starting large current discharging, so please calculate and evaluate with the normal working power consumption.

Load device power consumption Description:

1. IOP-USSS-12V1224-OA series product, the power consumption of the main control board: 0.5~1W/H (estimate as in 1W/H)
2. General surveillance cameras: 2.5~5W/H (estimate as in 3.6W/H)
3. Professional surveillance cameras for road surveillance, 3.5~6W/H (estimate as in 4.5W/H)
4. Infrared surveillance cameras, IR on: 4~8W/H (estimate as in 6W/H)
5. Professional infrared shield: 4~10W/H (estimate as in 6W/H)
6. Professional long-distanced IR projector: 8~12W/H (estimate as in 10W/H)
7. Video Server (analog to digital processor): 6~10W/H (estimate as in 8W/H)
8. Speed Dome Cameras: 8~12W/H (estimate as in 10W/H), with IR on, please add 6W/H (estimate as in 16W/H)
9. DVR with built-in 1 unit of 2TB Hard Disk drive: 8~14W/H (estimate as in 10W/H); plus 5W/H for 1 extra unit of hard drive
10. NVR with built-in 1 unit of 2TB Hard Disk drive: 8~14W/H (estimate as in 10W/H); plus 5W/H for 1 extra unit of hard drive



11. The network switches / hubs: 2~4W/H (estimate as in 3W/H)
12. Outdoor wireless equipment, normal RF output power:5~10W/H power consumption (estimate as in 8W/H); increased RF output power and MIMO-power consumption: 8~15W/H (estimate as in 12W/H); 1W high RF output power: 15~25W/H (estimate as in 22W/H)

Note1: Some devices have a fan for heat sink; please add the extra power consumption for the fan operation.

Note 2: Some devices have heater, please add the extra power for the heater operation.

Estimated DC UPS battery capacity calculation

Cloudy-Solar Energy Battery Charging Time: 6 hours

Cloudy-Solar Energy power voltage regulator uses: suggest designing 3-5 days (72-120 hours)

C-LiFePO4 Lithium Batteries Capacity V.S. C Value of charging and discharging

(C Value definition: hours of battery capacity and discharge current rate, such as: 1Ah battery capacity, amps to 1 A, =1C discharges 1 hour)

Suggest for charging current should be less than 0.5C, the discharging current should be less than 0.2C, to extend battery service life and power stability.

EX: With 6 unit of infrared surveillance cameras (6W/H)

Cloudy-Solar Energy set power voltage regulator uses: $6W/H * 6H * 6units * 110\% = 237.6W \Rightarrow 237.6W / 12.8V = 18.6Ah$

Recommended model: IOP-USSS-1224-09B -- 297 WH (23.2Ah @ 12.8V)
with 130W solar panel 22~24V/7A

Discharging current and discharging C value: $(6W * 6) / 12.8V = 2.8A \Rightarrow 2.8A / 23.2Ah = 0.12C < 0.2C$

Charging current and charging C value: $(237.6W / 4hr \text{ full charge}) / 12.8V = 4.6A \Rightarrow 4.6A / 23.2Ah = 0.19C < 0.5C$; $4.6A < \text{Solar Panel } 5A * 95\% = 4.75A$

EX: With 1 set of general surveillance camera(3.6W/H) and professional infrared shield (6W/H)

Cloudy-Solar Energy power voltage regulator uses:

3 day power consuming hours (Cloudy-Solar power AM 9:00~PM 4:00) = 18+18+18=54 hours



5 days power consuming hours (wet weather from solar-powered AM 9:00~PM 4:00)
=18+18+18+18+18=90 hours

3 days total power consumption: $9.6W \times 1Pcs \times 110\% \times 54Hr = 570W = 44.5Ah$

Recommended model: IOP-USSS-1247-10B -- 594 WH (46.4Ah @ 12.8V)

with 130W solar panel 22~24V/7A

Discharge current and discharge C value: $9.6W/12.8V = 0.72A \Rightarrow 0.72A/46.4Ah = 0.015C < 0.2C$

Charging current and charging C value: $(594W/8hr \text{ full charge})/12.8V = 5.8A \Rightarrow 5.8A/46.4Ah = 0.12C < 0.5C$; $5.8A < \text{Solar Panel } 7A \times 95\% = 6.65A$

5 days total power consumption for general surveillance camera:

$3.6WH \times 110\% \times 90Hr = 356W = 27.8Ah$

5 days total power consumption for Professional infrared shield:

$6WH \times 110\% \times 90Hr = 594W = 46.4Ah$

Recommended model: IOP-USSS-1247-10B -- 594 WH (46.4Ah @ 12.8V) * 2 Sets

with 2 individual sets of 130W solar panel 22~24V/7A

Surveillance cameras (3.6WH)-- Discharge current and discharge C value:

$3.6W/12.8V = 0.28A \Rightarrow 0.28A/23.2Ah = 0.012C < 0.2C$

Professional infrared shield (6WH)—Charge current and charge C value:

$6W/12.8V = 0.46A \Rightarrow 0.46A/23.2Ah = 0.02C < 0.2C$

Surveillance camera 3.6WH & professional infrared shield 6WH – Charge current and charge C value: $(594W/8hr \text{ full charge})/12.8V = 5.8A \Rightarrow 5.8A/46.4Ah = 0.12C < 0.5C$; $5.8A < \text{Solar Panel } 7A \times 95\% = 6.65A$

Note 1: Using C-LiFePO4 Lithium Batteries for supplying enough electricity for 3 years use may drop the capacity to 90~95%. To operate 3 years; please plus the battery aging compensation coefficient of 10%.

Note 2: The C-LiFePO4 Lithium Batteries voltage is 12.8V, different from lead-acid battery 12V. Therefore, C-LiFePO4 Lithium Batteries is $295.7W/12.8V = 23.1Ah$.

Note3: When designing the battery capacity for Solar-Energy DC UPS Power System, the designer needs to think about 1. How many rainy days in a series; 2. How many rainy days can the solar power system support the load devices in a series; 3. How long can the battery be fully charged..etc. To solve the continuous rainy or cloudy days, the designer may add another 20% or 30% of the



battery capacity. The added capacity may not be charged in one day, but once the sun shows up in the next day, the battery can still be fully charged.

Consideration for environmental characteristics (for C-LiFePO₄ Lithium Batteries)

Battery service life and service efficiency is influenced obviously by the factors below. Please take the factors in consideration.

1. Operating temperature: Lowest temperature shall be higher than -20°C , and highest temperature shall be lower than 60°C .
2. Discharge depth: Usually, the definition of full-charged battery state is at 95% capacity, @13.3V. When its voltage is @ 11V, the power capacity is about 2.13% left. Long-Term discharging deeply will speed up aging the batteries. Therefore, we suggest discharging 70%, and keeping 30% left, @ about 13V. It will obviously extend the battery service life.
3. The charging and discharging current: The recommended charging current should be less than 0.5C. And the recommended discharging current should be less than 0.2C. It will fully show the battery charging/discharging characteristics and performance. It can also extend the battery service life and slow down the battery aging.
4. Regularly re-charge the power: The self-discharging rate of C -LiFePO₄ Lithium Batteries is much less than other batteries. Remaining in high voltage can extend battery service life and slow down battery aging.



Product Installation Instructions

Click the Solar Energy joint (please do an extra waterproof protection)



This product series uses Tyco Patent connector. (TYCO) 1394462-4 (Male) & Tyco.

6-13994461-2 (Female) solar energy joint

When you purchase solar panels,
please be sure to advise the supplier
for Tyco patented joints.



DC M12 Male to DC M12 Female for input

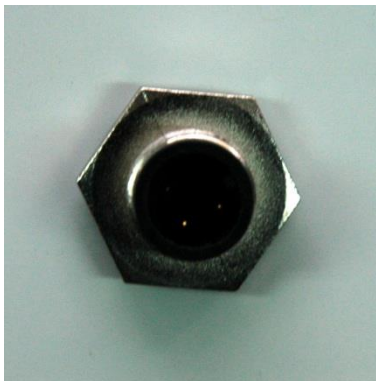

Take aim at M12 Male and plug in M12 Female and spin to tighten the connectors (please do an extra waterproof protection)



DC M12 Female to DC M12 Male for output



Take aim at M12 Female and plug in M12 Male and spin to tighten the connectors (please do an extra waterproof protection)

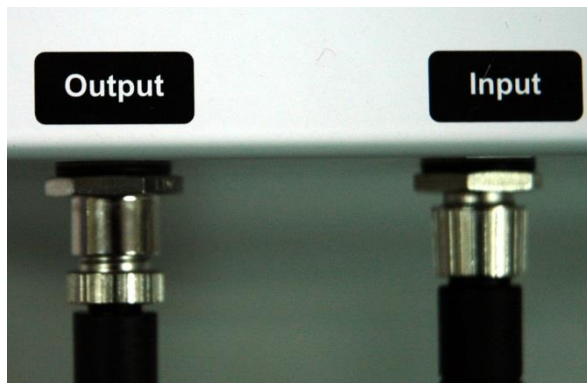

DC Extend Connector / DC Extend Cable

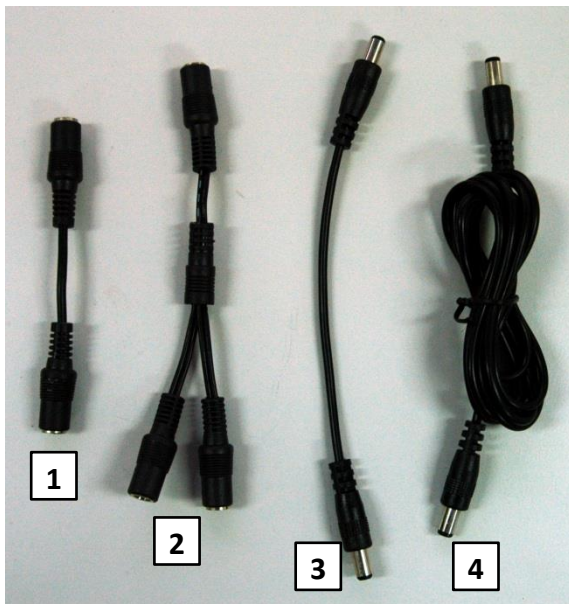

1. 1 DC Female to 1 DC Female 10.5cm (Female to Female, extended connector)
2. 1 DC Female to 2 DC Female 15cm (Female to Female, 1 to 2 extended distribution connector)
3. 1 DC Male to 1 DC Male 18.8cm (Male to Male, extended short cable)
4. 1 DC Male to 1 DC Male 150cm (Male to Male, extended long cable)

Mounting instruction

Firstly, put the waterproof rubber gaskets on the screws

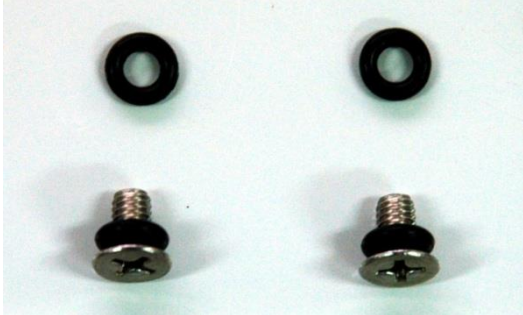

Then set the screw, through another set of waterproof rubber gaskets, on the stainless steel bracket



Finally, screw the bracket tight into the screw holes in the bottom side of the housing



Pole fixation

Suggest using stainless steel cable belt to pass through the stainless steel fixing brackets on either side of the hole, and then fix the belt tightly to poles or garden lamp posts or street light lay ... etc.

Wall fixation

Drill two holes on the wall, and put plastic plugs into the holes. And then screw the self-tapping stainless screws in. Finally, go through the stainless steel fixing brackets on either side of the holes, pressing down and keep the product fixed.



Product Use Instructions

External power input description

IOP-USSS-12V1224-OA series uses solar cell DC power input, voltage ranged DC 12V~28V with DC current 7A Max. The suitable solar panels are ranged 60W~140W/5~8A. The PCBA execute battery charging and discharging management. At the same time, it provides DC 11V~DC 14.4V to the load devices, such as surveillance cameras, DVR/NVR host, infrared projector.....etc.



First time to activate

After the outer power (converting from 12~28VDC to 18VDC) is put in, it will activate the system in 10 seconds. And then the PCBA will start to charge the C-LiFePO₄ Lithium Batteries, and supply for the supported equipment at the same time.

After the first time to activate the system, unless the DC UPS System executes the low-voltage-discharge-termination, it will keep working.

When the microprocessor detects the battery low voltage at 11V+/-3%, it will automatically execute the termination to avoid battery damage of low voltage.

DC power output description

IOP-USSS-12V1224-OA series uses built-in charging and discharging micro-controller with the online-power circuit design, online in real-time to discharge by C-LiFePO₄ Lithium Batteries, providing DC power 11V~DC 14.4V to load devices, such as surveillance cameras, DVR/NVR host, infrared projector ...etc.

When the battery discharges @ 11V+/-3%, the built-in micro-controller will automatically stop discharging and executes low-voltage-discharge-termination, the final low-voltage-discharge-termination is @ 9V+/-3%, and the high-voltage-discharge-termination is @ 14.4V+/-3%.



Recovery after low-voltage-discharge-termination instruction

IOP-USSS-12V1224-OA series uses built-in charging and discharging micro-controller. When battery discharging voltage is down to 11V+/-3%, it will execute low-voltage-discharge-termination. It will not discharge for the load devices until the outer power source is back in service. The micro-controller will discharge again when the battery voltage raise to 12.4V+/-3% voltage. (Usually, it needs 3-10 minutes, depending on the charging current)



C-LiFePO4 Lithium Batteries charging

IOP-USSS-12V1224-OA series adopts the latest technologies of high and low temperature resistance of C-LiFePO4 Lithium Batteries. It is very different from the other types of battery, like lead-acid batteries, deep cycle lead-acid batteries, and lithium ion battery characteristics. Besides, the different C-LiFePO4 Lithium Batteries products characteristics made by different manufacturers are also different both in voltage and current.

IOP-USSS-12V1224-OA series charging mode and charging voltage is as below:

Battery Charge Mode	CCP/CVP MCU Control
Battery Charge Voltage	14.4V +- 3%
Battery Charge Float Voltage	13.6V +- 3%
Battery Cut-off Discharge Voltage	11.5V +- 3%
Battery Final Cut-off Discharge Voltage	9V +- 3%

IOP-USSS-12V1224-OA series uses C-LiFePO4 Lithium Batteries, different voltage values the remaining power capacity is as follows (no load voltage): +-5%

Voltage(V)	Capacity (%)	Voltage(V)	Capacity (%)	Voltage(V)	Capacity (%)
14.10	100.00%	13.16	70%	12.60	13.72%
14.00	99.95%	13.13	65%	12.40	8.88%
13.80	99.85%	13.10	60%	12.20	7.14%
13.60	99.55%	13.08	55%	12.00	6.15%
13.40	98.80%	13.05	50%	11.80	5.38%
13.32	95%	13.03	45%	11.60	4.72%
13.28	90%	13.00	39.18%	11.40	4.14%
13.24	85%	12.98	35%	11.20	3.63%
13.20	78.55%	12.94	30%	11.00	3.15%
13.19	75%	12.80	21.40%	7.20	0.00%



LED Display

1. DC input (Solar Power DC), red light (charge) constant display (battery full status)
2. Input DC Power, flashing red light (charge) display (battery charging status)
3. Battery in charging, plug in 12V load device, the green light (discharge) flashing display or constant light display
4. Battery not in charging, plug in 12V device load insert, green light (discharge) constant light display



LED display considerations

1. When inputting abnormal DC voltage and LED red light flashing fast, please immediately remove the power supply to avoid danger.
2. When outputting DC power to the load device and LED green light flashing fast, please immediately remove the load device to avoid danger.
3. When other abnormal situation occurs, resulting in high temperature, please immediately remove the power supply and the load devices in order to avoid danger.
4. IOP-USSP-12V0206-II series uses built-in micro-controller to detect the battery charging and discharging voltage every 3 minutes, and executes charging and discharging management; even if battery is fully charged, micro-controller will still float-charge the battery in order to remain the best status and performance of C-LiFePO4 Lithium Batteries.
5. If the LED green light is flashing slowly without connecting to any load device, it is that micro-controller detects the output noise. When inputting the power, the flashing will disappear and it does not affect the charging and discharging functioning.
6. When you plug in a load device, but the LED green light is not on, it is that the lowest discharging current that micro-controller may detect is 300mA±10% (load device power consumption less than 3.5 W). If the power consumption of the load device is less than 300mA, the LED green light may not flash or constantly display, but it does not affect the charging and discharging functioning.

Product application

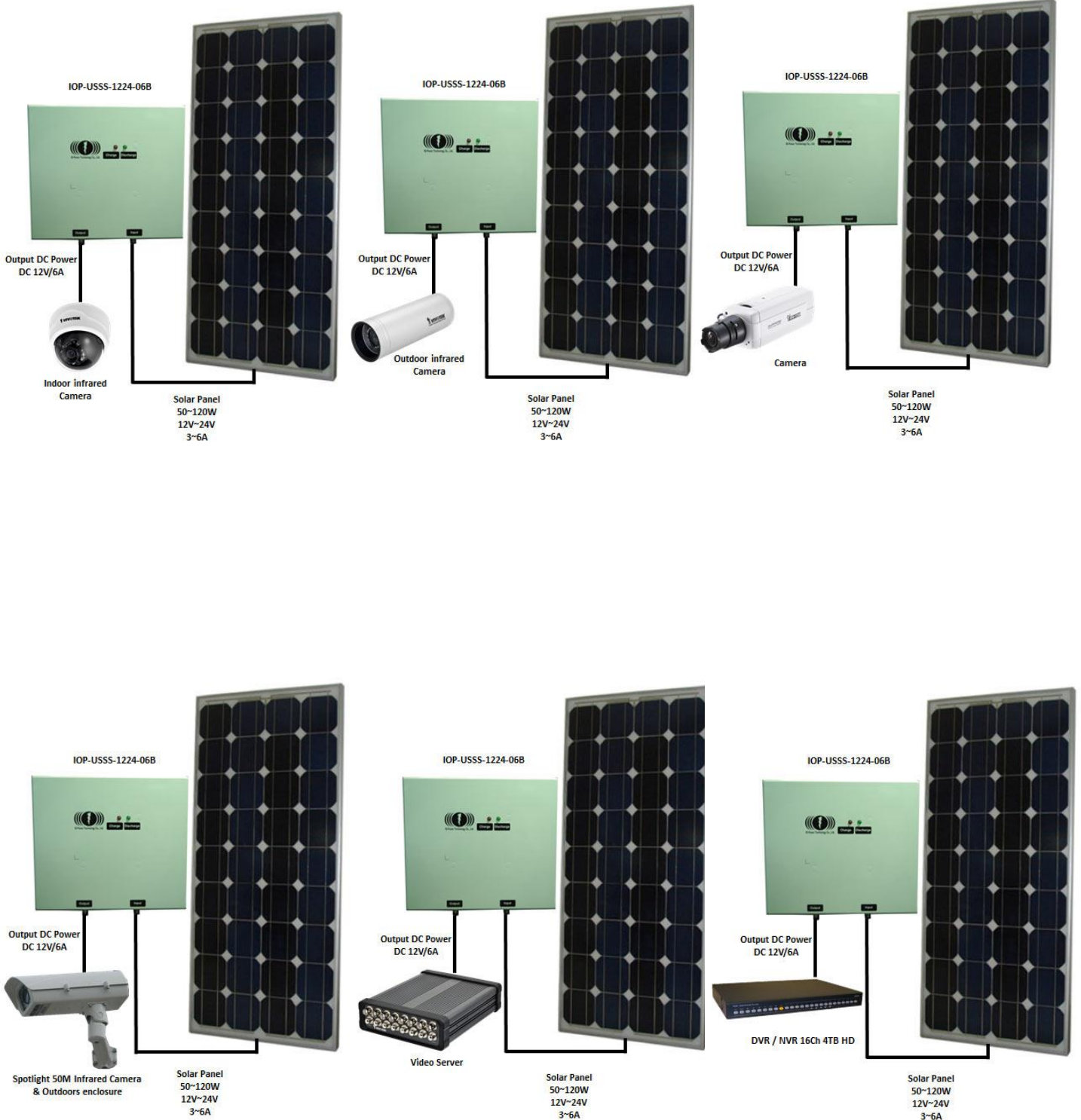



IO-Power Indoor/Outdoor 12VDC Online Type Uninterruptible Operation Power System Product Series For (IR) Speed Dome 24VAC Power Supply Solutions

Applicable Products:



Solution Architecture:

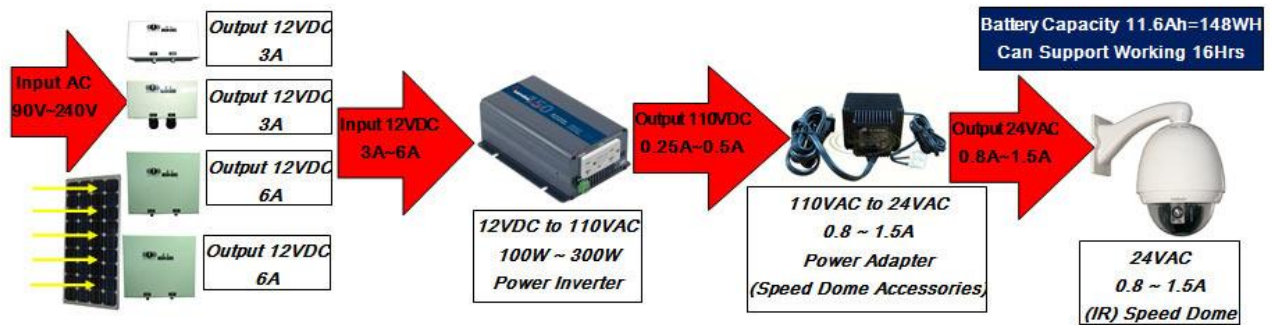

Form No. : IOP-OANC-001-001

Rev. : A.1

Retention date : 6Years

IO-Power Indoor/Outdoor 12VDC Online Type Uninterruptible Operation Power System Product Series For Outdoor Wireless MIMO AP PoE-48VDC Power Supply Solutions

Applicable Products:



Solution Architecture:

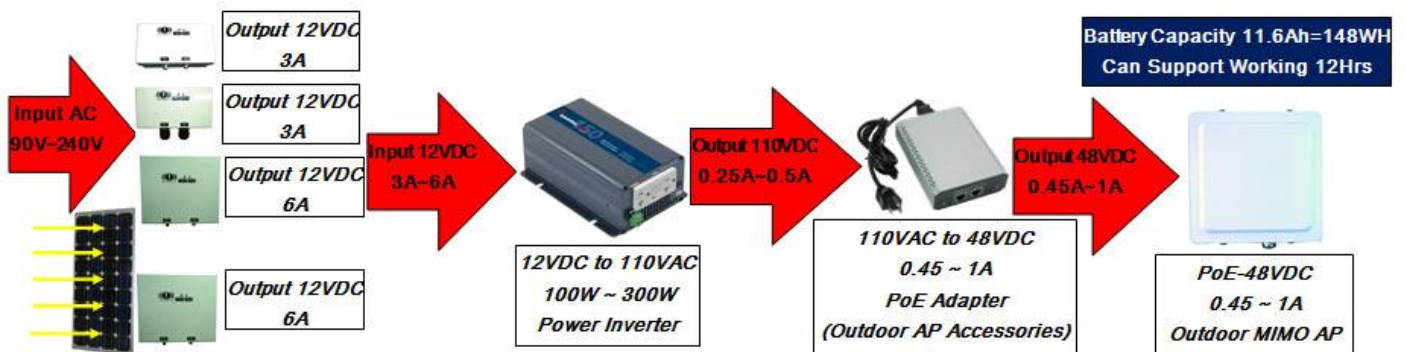

Form No. : IOP-OANC-001-001

Rev. : A.1

Retention date : 6Years

Outdoor Wireless Surveillance with Street Lamps & Solar Collection UPS System

